

Candidate Name	Centre Number					Candidate Number				
						0				



GCSE

MATHEMATICS - NUMERACY

UNIT 2: CALCULATOR-ALLOWED
HIGHER TIER

SPECIMEN PAPER SUMMER 2017

1 HOUR 45 MINUTES

ADDITIONAL MATERIALS

A calculator will be required for this paper.

A ruler, protractor and a pair of compasses may be required.

INSTRUCTIONS TO CANDIDATES

Write your name, centre number and candidate number in the spaces at the top of this page.

Answer **all** the questions in the spaces provided in this booklet.Take π as 3.14 or use the π button on your calculator.**INFORMATION FOR CANDIDATES**

You should give details of your method of solution when appropriate.

Unless stated, diagrams are not drawn to scale.

Scale drawing solutions will not be acceptable where you are asked to calculate.

The number of marks is given in brackets at the end of each question or part-question.

The assessment will take into account the quality of your linguistic and mathematical organisation, communication and accuracy in writing in question 1.

For Examiner's use only		
Question	Maximum Mark	Mark Awarded
1.	6	
2.	7	
3.	7	
4.	5	
5.	5	
6.	4	
7.	12	
8.	7	
9.	10	
10.	4	
11.	13	
TOTAL	80	

Formula list – Higher tier

Area of a trapezium = $\frac{1}{2}(a + b)h$

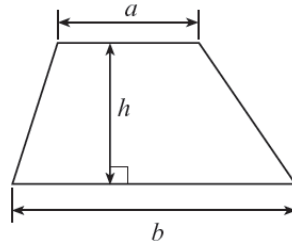

Volume of a prism = area of cross section \times length

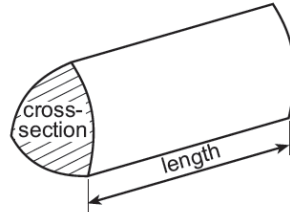

Volume of a sphere = $\frac{4}{3}\pi r^3$

Surface area of a sphere = $4\pi r^2$

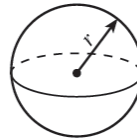

Volume of a cone = $\frac{1}{3}\pi r^2 h$

Curved surface area of a cone = $\pi r l$

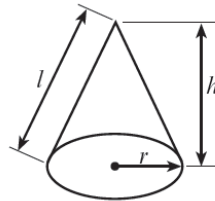

In any triangle ABC ,

Sine rule: $\frac{a}{\sin A} = \frac{b}{\sin B} = \frac{c}{\sin C}$

Cosine rule: $a^2 = b^2 + c^2 - 2bc \cos A$

Area of triangle = $\frac{1}{2}ab \sin C$

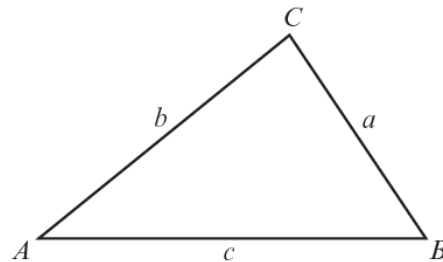

The Quadratic Equation

The solutions of $ax^2 + bx + c = 0$ where $a \neq 0$ are given by $x = \frac{-b \pm \sqrt{b^2 - 4ac}}{2a}$

Annual Equivalent Rate (AER)

AER, as a decimal, is calculated using the formula $\left(1 + \frac{i}{n}\right)^n - 1$, where i is the nominal interest rate per annum as a decimal and n is the number of compounding periods per annum.

2. Layla is investigating how much people would be prepared to pay for a bottle of water at an Eisteddfod.



Amount of money (£x)	Number of people
$0 \leq x < 1$	12
$1 \leq x < 2$	44
$2 \leq x < 3$	20
$3 \leq x < 4$	4

She asked a number of people at a concert on Monday how much they would be prepared to pay.

Monday's results are summarised in the table.

- (a) Calculate an estimate for the mean amount of money that a person would be prepared to pay for a bottle of water. [4]

.....

.....

.....

.....

.....

.....

- (b) Monday was a cool day.
 On Tuesday, it was much warmer.
 Layla asked a further 60 people the same question as she did on Monday.
 On Tuesday, the mean was £2.30.

Use the data collected over the two days to calculate an estimate for the mean amount of money that a person would be prepared to pay for a bottle of water.

Give your answer correct to the nearest penny. [3]

.....

.....

.....

.....

.....

3. Jane and Tomos own a sandwich business.

- (a) They decide to price sandwiches individually each morning.
At 3 p.m. any unsold sandwiches are reduced by 45%.
Any sandwiches still unsold by 4:30p.m. are reduced by a further 20%.

Jane says

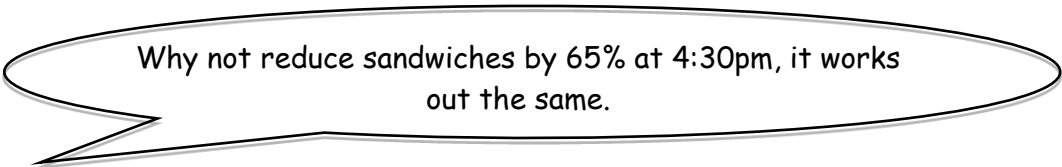

Tomos disagrees with Jane.

Using multipliers, show that Jane is incorrect. [4]

.....

.....

.....

.....

.....

.....

.....

- (b) Write down and simplify two formulae, in terms of P , to calculate the reduced prices of sandwiches at 3 p.m. and at 4:30 p.m.

Let

- P be the full price of the sandwich.
- T be the price of a sandwich at 3p.m.
- R be the price of a sandwich after 4:30p.m. [3]

.....

.....

.....

.....

.....

.....

4.

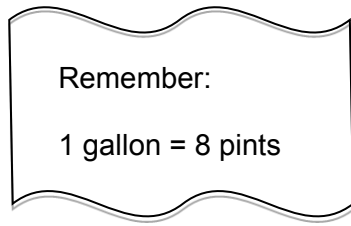

Lowri owns an old van.

It has an average fuel consumption of 7 km per litre.

Calculate an estimate for this fuel consumption in miles per gallon.

[5]

.....

.....

.....

.....

.....

.....

6. *NwyCymru* gas company uses the following formula to calculate how much to charge its customers:

$$\text{charge (in pence)} = (\mathbf{U} \times 11.546 + \mathbf{D} \times 31.48) \times 1.05$$

The number of units of gas used by a customer is **U** and the number of days in the billing period is **D**.

A customer was charged £165.53 over a billing period of 90 days.

Calculate the number of gas units this customer used during this period.

[4]

.....

.....

.....

.....

.....

.....

7. Pack4 is a company that makes cardboard boxes.
(a) One of their boxes, in the shape of a triangular prism, is shown below.

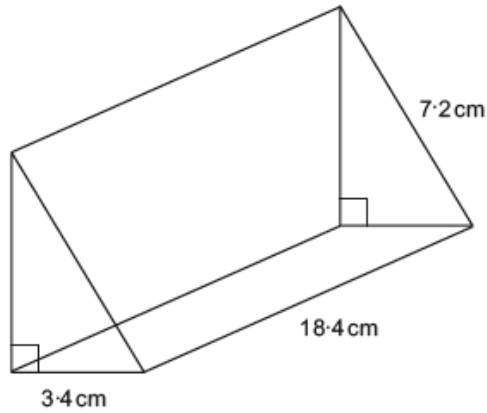

Diagram not drawn to scale

A customer wants a box with a volume of 0.2 litres.

- (i) State by how much the volume is greater or less than 0.2 litres, giving your answer in cm^3 correct to 2 significant figures. [6]

.....

.....

.....

.....

.....

.....

.....

.....

.....

- (ii) Explain why this may not be a suitable box for the customer. [1]

.....

.....

.....

.....

- (b) Which two countries have the same population densities to the nearest whole number of people per km²? [1]
Circle your answer.

India
and
Belgium

Wales
and
Tonga

Singapore
and
Tonga

Wales
and
Belgium

Bermuda
and
Tonga

- (c) If the information in the table had all been given correct to 2 significant figures would this make a difference to your answer in part (a)? [2]

Circle either TRUE or FALSE for each of the following statements.

No difference at all, the answer would be exactly the same.	TRUE	FALSE
One of the countries used in the comparison would be different.	TRUE	FALSE
Both countries used in the comparison would be different.	TRUE	FALSE
The only difference would be in rounding the final answer, nothing else in the calculation changes.	TRUE	FALSE
You cannot tell whether there would be a difference in the answer in part (a) if the information in the table had all been given correct to 2 significant figures.	TRUE	FALSE

9. *Blodyn Garden Products* makes caps for fence posts.

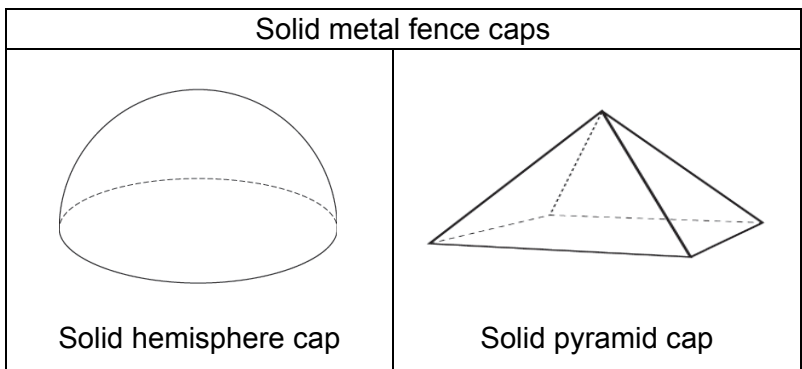

Blodyn Garden Products wants to make the price of the two different fence caps the same.

So it is important that the volume of metal used to make each cap is the same.

The lengths of the sides of the base of the pyramid are all 8 cm.

The angle between one of the sloping edges and the diagonal of the base is 32° .

(a) Calculate the height of the square-based pyramid cap. [5]

.....

.....

.....

.....

.....

(b) Calculate the volume of the square-based pyramid cap. [2]

.....

.....

.....

.....

.....

(c) Calculate the radius of the hemispherical fence cap. [3]

.....

.....

.....

.....

.....

10. (a) A School Council wants to know pupils' views on their school uniform. Which of the following statements shows how a truly random sample of the general population can be obtained? [1]
Circle your answer.

A: Randomly selecting pupils in the canteen at lunchtime.

B: Randomly selecting pupils from those that attend the next School Council meeting.

C: Randomly selecting pupils with a surname beginning with the letter J.

D: Giving each pupil a raffle ticket and then randomly drawing raffle tickets for selection.

E: Selecting every 2nd pupil from each form register.

- (b) *VotePredict* is a specialist company working in the field of polling and predicting voting patterns in elections worldwide. They are asked to organise a debate with an audience that is representative of five political parties. The five political parties and their predicted number of votes, given in alphabetical order, are as follows.

Political Party	Predicted votes
Central	23 456
Economy	43 244
First Reformists	83 124
Status Quest	11 782
West Term	63 789

The invited audience should be a stratified sample using this information.

It is intended to have 250 people in the audience at the debate.

How many people who intend to vote for the Central Party should be in the audience? [3]

.....

.....

.....

.....

.....

11. Imran works for a company called *Derwen Insurance*. His gross salary is £47 840 per year.

Below are extracts from HM Revenue and Customs and details of Imran's company pension scheme:

National Insurance contributions	
•	If you earn more than £153 a week and up to £805 a week, you pay 12% of the amount you earn between £153 and £805
•	If you earn more than £805 a week, you also pay 2% of all your earnings over £805

Source: HMRC 2014

Income tax threshold and rates	
Income tax threshold	£10,000 per year
Basic tax rate	20% on annual earnings above income tax threshold and up to £31,865
Higher tax rate	40% on annual earnings from £31,866 to £150,000
Additional tax rate	45% on annual earnings above £150,000

Source: HMRC 2014

<i>Derwen Insurance</i> Pension Scheme			
Gross salary	Contribution rate	Gross salary	Contribution rate
Up to £13 500	5.5%	£60 001 to £85 000	9.9%
£13 501 to £21 000	5.8%	£85 001 to £100 000	10.5%
£21 001 to £34 000	6.5%	£100 001 to £150 000	11.4%
£34 001 to £43 000	6.8%	£150 001 or more	12.5%
£43 001 to £60 000	8.5%		

