



VITAI

VDG-360



DIGITAL TWO-WAY RADIO

USER'S MANUAL

DMR

User Manual

Digital Two-way Radio

We are very grateful for your purchasing VITAI brand two-way radios produced by VITAI Electronics Co.,Ltd.

We believe VITAI two-way radio, which always incorporates the latest technology, can bring great convenience to your life and work.

We also believe that the quality and function of VITAI two-way radio can meet your demands for reliable communication.

Notice to user

◆ Copyright

VITAI and our authorized partners own the intellectual property of all the parts of this product (include accessories). Any design and materials may not be modified, copied, extracted or translated without the authorization of VITAI or its authorized parities.

Due to the update or modification of the product, VITAI owns the right to change the specifications of software and hardware described in this manual without further notice. Specifications and information contained in this manual are for reference only.

◆ Safety Information

Compliance with RF Exposure Standards

Your radio is designed and tested to comply with a number of national and international standards and guidelines (listed below) regarding human exposure to radio frequency electromagnetic energy. This radio complies with the IEEE and ICNIRP exposure limits for occupational/controlled RF exposure environment at operating duty factors of up to 50% transmitting. In terms of measuring RF energy for compliance with the IEEE and ICNIRP exposure limits, your radio radiates measurable RF energy only while it is transmitting (during talking), not when it is receiving (listening) or in standby mode.

Your radio complies with the following of RF energy exposure standards and guidelines

Institute of Electrical and Electronic Engineers (IEEE) C95.1-1992

Institute of Electrical and Electronic Engineers (IEEE) C95.1-1999 Edition

International Commission on Non-Ionizing Radiation Protection (ICNIRP) 1998

◆ Operating Instructions to control RF Exposure

To decrease your exposure and ensure compliance with the occupational/controlled environment exposure limits, please always adhere to the following procedures.

1. Transmit no more than the rated duty factor of 50% of the time. To transmit, press the PTT button, and to receive the call, release the PTT button.
2. Keep your radio in a vertical position in front of the face with the microphone 5cm away from your mouth while transmit.
3. When worn on your body, keep the antenna 2.5cm away from you body while transmit.
4. Do not transmit when the radio is not equipped with an antenna. Transmitting without an antenna may damage the product and result RF discomfort.

◆ Using the designated accessories

Use the antenna, battery, adapter or charger supplied or sold by VITAI only, or otherwise it causes damage to the product.

If you want to purchase or replace the accessories, please contact your local dealer or VITAI.

◆ Area restrictions

1. To avoid of the problems caused by electromagnetic interference or electromagnetic compatibility, turn off the radio in any facilities where posted notices instruct you to do so, such as hospital and other health care facilities. Turn off the radio when on board an aircraft, if instructed to do so.
2. In the vehicle with an air bag, do not place the radio in the area over an air bag or in the air bag deployment



area.

3. Turn off the radio before entering any area with a potentially explosive atmosphere or blasting caps.
4. Do not operate the radio, disassemble or charge the battery in the potentially flammable and explosive atmosphere (such as gas station, coal gas station, etc.).
5. Do not place the radio under the direct sunlight or near the area with heating devices.
6. Do not place the radio in the area with great dust, moisture or drips, or on the unstable surface.

◆ Operating Attentions

Antenna

Do not use any portable radio that has a damaged antenna. If a damaged antenna comes into contact with your skin, a minor burn can result.

Batteries

All batteries can cause property damage and/or bodily injury, such as burns, if a conductive material such as jewelry, keys, or beaded chains touches exposed terminals. The conductive material may complete an electrical circuit (short circuit) and become quite hot. Excessive care in handling any charged battery, particular when placing it inside a pocket, purse, or other container with metal objects. To reduce the potentially damage, do not expose the battery in the fire, or disassemble and extrude the battery.

To realize the best performance of the battery, change the battery once a year.

Maintenance

Do not disassemble the radio by yourself. This product can only be maintained by the professional technicians. Contact us or your local dealer for help if you want to re-develop or modify the radio.

Regulatory



Kirisun declares that this product is compliant with the essential requirements and other relevant provisions of the European Directive 2014/53/EU relating to radio and telecommunications terminal equipment and the mutual recognition of their conformity. This product is also compliant with directive 2011/65/EU having been designed and manufactured to the RoHS requirements.

Restrictions Frequencies are valid for the European country

Country	Frequency Range(MHz)	Max. transmit power (W)
Germany(DE)	406.1-430 ,440-470	4
France (FR)	406.1-430,444.5-447, 451.5-460, 461.5-470	4
United Kingdom (UK)	410-430 ,440-470	4
Italy(IT)	440-443,445-470	4
Greece(EL)	406.1-430 ,440-470	4
Spain(ES)	406.1-430 ,440-470	4

Country	Frequency Range(MHz)	Max. transmit power (W)
Ireland (IE)	410 - 430,440 - 455, 456 - 459,460 - 470	4
Belgium(BE)	406.1-430 ,440-470	4
Croatia (HR)	406.1-430 ,440-470	4
Cyprus (CY)	406.1-430 ,440-470	4
Portugal (PT)	440-470	4
Malta(MT)	406.1-430 ,440-470	4
Luxembourg (LU)	410-430,440- 470	4
Bulgaria(BG)	410 -430,440-470	4
Latvia (LV)	406.1-430,440-450,456 -470	4
Slovenia(SI)	406.1-430 ,440-470	4
Czech Republic(CZ)	448 - 451.3,457.38 - 461.3,467.38 - 470	4

Country	Frequency Range(MHz)	Max. transmit power (W)
Denmark(DK)	406.1-430,450 - 470	4
Estonia(EE)	406.1 - 410,412.5 - 420, 422.5-430,440 - 442.5, 443 - 450,446 -446.2,450 -453,457.575 - 463,467.575 -470	4
Lithuania(LT)	406.1 - 410 , 413 - 418.6 ,423- 428.6 ,440 - 450 , 450 - 452.9875 ,458.1125 - 462.9875 ,467.4875 - 467.5875	4
Hungary(HU)	417 - 420,442 - 445,456 - 460, 461.3 - 470	4
Netherlands(NL)	410 -430,440-470	4
Austria(AT)	444.9 - 444.900001, 450 - 456, 457.33 - 457.330001, 457.45 - 458.3,460 -470	4
Poland(PL)	448 - 449.5,457 - 460,467 - 470	4
Romania (RO)	408 - 410.8,415 - 420.8,425 - 429.8, 440 - 450.55, 457.5 - 458.2, 460 - 460.55,467.5 - 468.2	4

Country	Frequency Range(MHz)	Max. transmit power (W)
Slovakia(SK)	441.025 - 451.31,455.73 - 461.31,465.73- 470	4
Finland(FI)	407.525 - 408.55,410.0125 - 410.8875,417.525 - 417.9, 419.15 - 419.525,419.55625 - 419.71875,420.0125 - 420.8875,426.35 - 427.5,427.525 - 427.9, 429.15 - 429.525,429.55625- 429.71875,440.0125 - 440.5875, 440.60625 - 440.89375,442.775 - 443, 443.025 - 444, 444.025 - 444.525,444.55 - 444.975,445 - 446, 447.00625 - 447.29375,447.30625 - 447.70625, 449.025 - 449.525,449.55 - 449.975, 450.325 - 452.475, 452.525 - 452.975,453.0125 - 453.6625,469.725 - 469.975	4
Sweden(SE)	406.1 -430, 442 - 444,444.5875 - 452.5, 457.5 - 462.5,467.5 - 470	4

Restrictions are valid for the European country

Restrictions are valid for the following countries:

France (FR), United Kingdom (UK), Italy(IT), Ireland (IE), Portugal (PT), Luxembourg (LU) , Bulgaria(BG) , Latvia (LV), Czech Republic (CZ) , Denmark(DK), Estonia(EE), Lithuania(LT) , Hungary(HU) , Netherlands(NL) , Austria(AT), Poland(PL), Romania (RO) , Slovakia(SK) , Finland(FI) , Sweden(SE)

Waste Electrical and Electronic Equipment recycling



This symbol on the product or its packaging indicates that this product must not be disposed of as household or commercial waste. Some countries have set up collection and recycling systems for waste electrical and electronic products. By ensuring that this product and its packaging is disposed of correctly, you will help prevent potentially negative consequences for the environment and human health, and help conserve natural resources. Please dispose of your waste product according to your national and local regulations. Contact your service provider or Kirisun for information about disposing of this product in your region of the world.

Disposing of batteries



Your radio is supplied with a rechargeable lithium-ion battery. This symbol on the battery and its packaging indicates that it must not be disposed of with household or commercial waste. Please dispose of your waste batteries according to your national and local regulations. Contact your service provider or Kirisun about recycling batteries in your region of the world.



US Markets**FCC radiation exposure statement**

This radio is intended for use in occupational/controlled applications where users have been made aware of the potential risks for exposure and can exercise control over their exposure. This product is not authorised for general population, consumer or similar use.

This transmitter must not be co-located or operated in conjunction with any other antenna or transmitter.

DIGITAL
TWO-WAY RADIO

X

Content

REGULATORY	V
RESTRICTIONS FREQUENCIES ARE VALID FOR THE EUROPEAN COUNTRY	V
RESTRICTIONS ARE VALID FOR THE EUROPEAN COUNTRY.....	IX
<i>Disposing of batteries</i>	<i>IX</i>
<i>FCC radiation exposure statement</i>	<i>X</i>
1 UNPACKING AND CHECKING	1
1.1 SUPPLIED ACCESSORIES	1
2 BATTERY INFORMATION	2
2.1 NOTICE.....	2
2.2 BATTERY CHARGING	3
3 ATTACHING THE ACCESSORIES	4
3.1 ATTACHING/DETACHING THE BATTERY	4
3.2 ATTACHING/DETACHING THE ANTENNA	4
3.3 ATTACHING/DETACHING THE BELT CLIP.....	5
3.4 ATTACHING THE MICROPHONE	5

4	INTRODUCTION	6
5	PROGRAMMABLE KEYS	8
5.1	PROGRAMMABLE KEYS	8
5.2	LED INDICATION	9
6	BASIC OPERATION	10
6.1	POWER ON/OFF THE RADIO	10
6.2	SELECTING THE CHANNEL	10
6.3	ADJUSTING THE VOLUME	11
6.4	INITIATING A CALL	11
6.5	RECEIVING	11
6.6	REPLYING TO THE CALL	11
7	FEATURES AND OPERATION	12
7.1	TOT (TIME-OUT-TIMER)	12
7.2	CHANNEL SCAN	12
7.3	SCAN THE REPLY MESSAGE	12
7.4	PRIORITY SCAN	12

7.5	KILL AND UNKILL.....	13
7.6	EMERGENCY.....	13
7.7	ENABLING COLOR CODE ON DIGITAL MODE	14
7.8	TECHNICAL PARAMETERS.....	14
8	TROUBLE SHOOTING	15

1 Unpacking and Checking

Please carefully open the box, and check if the accessories listed below are contained in the package. For any missed or damaged item, please contact your local dealer for solution.

1.1 Supplied Accessories

Material	Quantity
Radio	1
Charger	1
Power Adaptor	1
Battery	1
Belt Clip	1
Antenna	1
Strip	1
User Manual	1

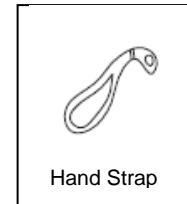
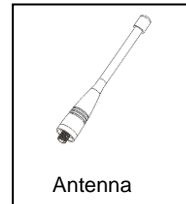
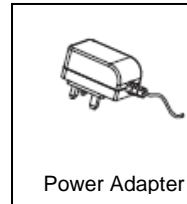
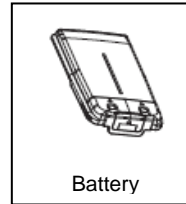
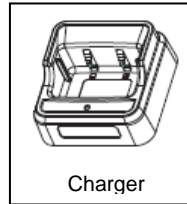

2 Battery Information

2.1 Notice

The battery is not charged before delivery, so please charge the battery for your first use. If the battery is not used for a long time or the battery is used up, please charge it before use. Charge/discharge for twice or three times alternately to achieve its optimal performance. For low battery, please charge it or replace it.

Note:

- ◆ Do not cause any short circuit on the battery or throw the battery into fire.
- ◆ When attaching the battery to the radio for charging, please make sure the radio is powered off to guarantee it can be fully charged.
- ◆ Do not leave the radio or battery on the charger after it is fully charged. Unnecessary constant charging will shorten the battery life.
- ◆ Do not put the fully-charged battery back to the charger for re-charging, or it may shorten the battery life.
- ◆ Please try to keep the battery in an indoor environment at around 25°C. The battery may get easily spoiled after being kept in the environment below -10°C for a long time.
- ◆ In temperature higher than 35°C or below -10°C, the dischargeable power of the battery may decrease due to the physical property of lithium battery.

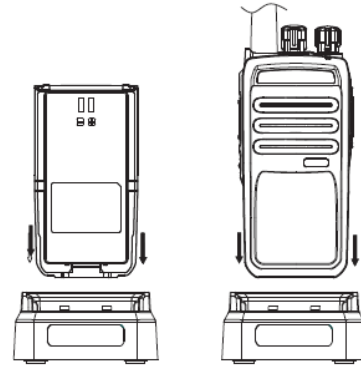
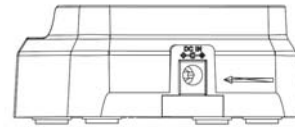

2.2 Battery Charging

- (1) Plug the power adaptor in the proper socket of AC power.
- (2) Plug the cable of the power adaptor at the back of the socket, and the green indicator glows.
- (3) Plug the battery or radio in the charger.
- (4) Make sure that the battery is in proper contact with the charger terminal, and the red indicator glows.
- (5) After the battery is charged for 6 hours, the red light goes out, indicating that the battery is fully charged.
- (6) When the green indicator glows, keep the battery on the charger for 1-2 hours before taking it out so as to achieve the optimal performance.
- (7) Take out the power adaptor from the socket of AC power output.

Note:

- ◆ The battery is not charged before delivery from the factory, so please charge the battery before your first use.
- ◆ KB-360 lithium-ion can be used for this radio.
- ◆ If the battery which is stored for over 2 months or a new battery is charged for the first time, it should be charged repeatedly to gain full battery capacity. The battery should be at least charged once every three months.
- ◆ When the battery is fully charged or the battery power is above the level of low power alert, do not charge the battery, or it may affect the battery life and performance. Please take out the battery from the charger after it is fully charged.
- ◆ When the radio enters the state of low voltage alarm, please charge the battery before using it and do not force to power on the radio in case that the battery life and performance is impaired.
- ◆ There is protection circuit inside KB-360 lithium battery. The power supply will be cut off in state of low power, and when you charge it in the charger, the indicator will glow after 1-5 minutes.

3 Attaching the Accessories

3.1 Attaching/Detaching the Battery

◆ Attaching the Battery

(1) Slightly press the top of the belt clip as shown in ①;

◆ Detaching the battery

(1) For detaching the battery, please first turn off the radio.

(2) Slide the battery latch along the direction as shown in ① to bounce the battery as shown in ②.

(3) Slide to take out the battery along the direction as shown in ③. If there is belt clip, slightly press the belt clip top as shown in ④ and slide the battery along the direction as shown in ③ to take out the battery.

Note:

- ◆ Do not throw the battery terminals with short circuit or battery into fire.
- ◆ Do not remove the battery case without permission.

3.2 Attaching/Detaching the Antenna

For attaching the antenna, put the antenna's end with screw thread into the

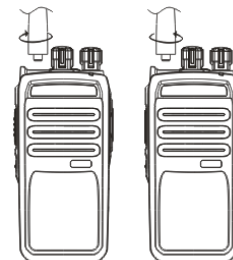
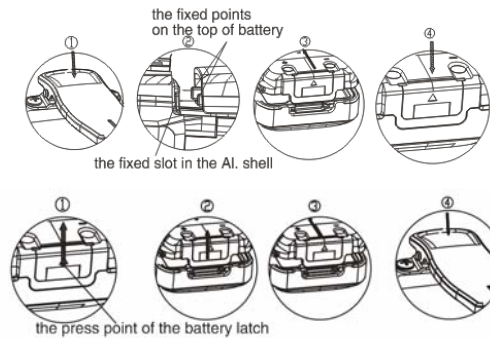

antenna port.

Turn the antenna clockwise until it is fixed.

For detaching the antenna, turn it counter-clockwise.

3.3 Attaching/Detaching the Belt Clip

Align the two screws on the belt clip with the screw holes at the back of the radio.

Use two 2.5x6.5 machine screws.

When detaching, loosen the two screws on the belt clip and remove the belt clip.

M2.5*6.5 screw to
fasten the belt clip

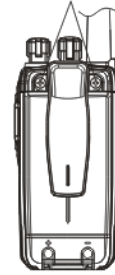

3.4 Attaching the Microphone

Open the earphone cover plate on the right and
connect the earphone cable to the port.

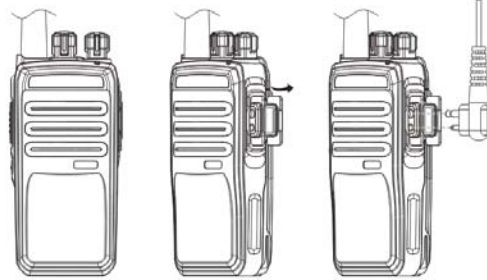

4 Introduction

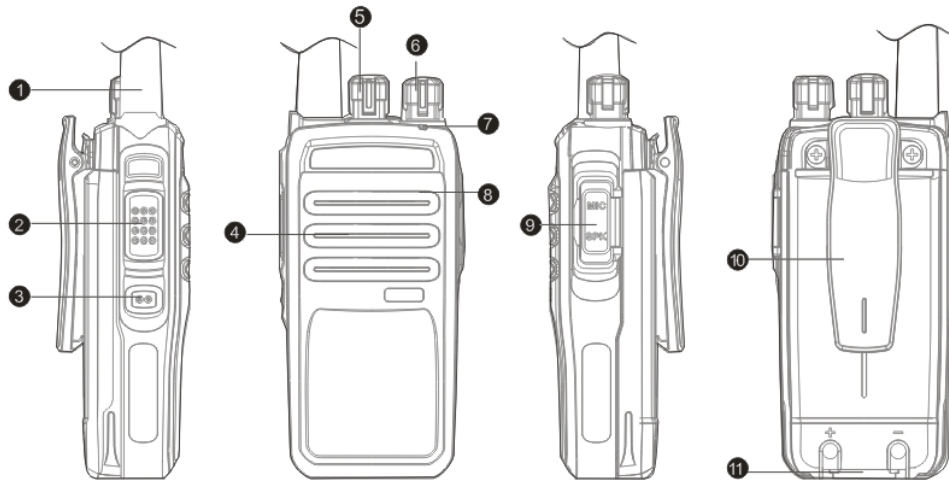

No.	Part Name
1	Antenna
2	PTT key Press this key to initiate a call and talk
3	Side key (programmable key) This key can be set with different features by dealer. Please refer to "5 Programmable Keys" for further details
4	Speaker Voice Output.
5	Channel Knob Rotate the knob to select channel 1-16.
6	Power/Volume Knob Turn it clockwise to turn on the radio. For turning off the radio, turn it counter-clockwise until a click is heard. When the radio is on, rotate the knob to adjust the volume.
7	LED Indicator Red indicator means the radio is transmitting, green means receiving and when the red indicator flashes, it means power shortage.
8	Microphone Voice input
9	External port Open the cover plate and connect the external speaker and microphone
10	Belt Clip
11	Battery Latch

5 Programmable Keys

5.1 Programmable Keys

To suit the operation habits of customer, programmable keys (side keys) are available and can be set by dealer as shortcut key.

Note:

Short Press: press and release quickly.

Long Press: press and hold for a while (press duration can be set by programming software)

No.	Programmable Feature	Application
1	None	No feature
2	High/Low Power	Switch to high and low power
3	Monitor	If the current analogue channel has CTCSS, press this key and switch to carrier squelch mode to cancel CTCSS; press it again to go back to the original state.
4	Emergency	Starts the emergency feature. Used for seeking help in emergency.
5	Emergency Exit	Exits the emergency state.

6	Squelch on/off	Enable/Disable squelch feature. Used for receiving the weak signals on the analogue channel.
7	Squelch Level	Adjusts the signal strength required when receiving.
8	Scan	Enable/Disable scan feature and listens to the communication activities on other channels.
9	Alert Tone on/off	Enable/disable all the alert tones.
10	Zone Selection	Press this key to switch among different zones. The zones are programmed by programming software.
11	Repeater/Talk around	Enable/disable Repeater feature.
12	Nuisance Delete	Deletes the channel which is useless from the scan list.

5.2 LED Indication

State	Operation
Glow red	Transmitting
Glow green	Receiving

Flashes red	Low battery
Flashes green	Channels are being scanned
Flashes orange	Digital call hang time and it will exit when the hang time is up
Glow orange	Blank channel which is not available. Switch to other channel to exit.
Flashes red quickly	The programming software is reading the parameters available for configuration
Flashes green quickly	The programming software is writing the parameters which is available for configuration into the radio.

6 Basic Operation

6.1 Power on/off the Radio

When the radio is off, rotate the power/volume knob clockwise until a click is heard to power on the radio.
When the radio is on, rotate the power/volume knob counter-clockwise until a click is heard to turn off the radio.

6.2 Selecting the Channel

When the radio is on, rotate the channel selector knob to select channels.

6.3 Adjusting the Volume

When the radio is on, rotate the power/volume knob clockwise to increase the volume and counter-clockwise to decrease the volume.

6.4 Initiating a Call

Press PTT button to initiate a call to the default contact on the current channel when it is digital channel. The default contact on the current channel can be programmed by dealer.

6.5 Receiving

When the radio receives the right signal on the current channel and green LED will light.

When the current channel is digital channel and when it received private call, group call or all call, the radio will output the voice from the channel.

When the channel is analogue channel and when it received analogue signals with CTCSS matching the one on this channel (or there is no CTCSS set on the channel), the radio will output voice form the channel.

6.6 Replying to the Call

When the current channel is digital channel and after a call is received, press PTT button within the call hang time to reply. If the call hang time is up, you need to initiate a call to reply. The call hang time can be set by dealer.

When the current channel is analogue channel and after a call is received, press PTT button within the call hang time and speak to the microphone to reply.

7 Features and Operation

7.1 TOT (time-out-timer)

TOT prevents the user from occupying the channel for too long. If the continuous transmission exceeds the duration set by dealer, the radio will stop transmitting and sound alarm. For stopping alarm, release PTT button. For transmission again, please press PTT button after a certain time interval (interval set by dealer).

If the dealer set pre-alarm feature, pre-alarm will sound before TOT time is up.

7.2 Channel Scan

Channel scan searches channels with signals. When the channel scanned has signals, the radio will stay on this channel for communication. Scan method is carrier control scan.

By pressing the Scan shortcut key, the radio can scan the scan list related to the current channel. When the radio is in scan state, press the Scan shortcut key again to stop the scan.

7.3 Scan the Reply Message

When the radio is scanning, press PTT button and the radio will transmit and talk on the predefined channel. This channel is set by dealer.

7.4 Priority Scan

When there is priority scan set in the scan list, the priority scan will be automatically enabled when the radio starts the scan feature. The priority scan mode is cycle scan, and it scans priority channel every time when it scans a conventional channel. For example, if there are channel 1, 2, 3, 4 in the scan list and channel 2 is priority channel, the scan cycle will be 1->2->3->2->4->2->1.

7.5 Kill and Unkill

If the dealer enables and sets Kill and Unkill, the radio is able to receive and decode the Kill/Unkill signals from other radios. After being killed, the radio cannot transmit or receive any signals but activation signal. After being activated, the radio will be back to normal state. Kill/Unkill feature is valid on digital mode.

7.6 Emergency

In state of emergency, press the Emergency shortcut key to send emergency alarm.

Emergency alarm consists of two parts: alarm type and alarm mode. Alarm mode is used to specify the contents sent to other members in emergency. You can ask your dealer to set these parameters based on your requirements.

For exiting emergency, press again the Emergency shortcut key.

◆ Alarm Mode

Emergency Alarm: enable to send alarm and exit alarm state automatically afterwards.

Emergency Alarm + Emergency Call: after the radio sends emergency alarm, press PTT button to send emergency call.

Emergency Alarm + Auto Background Tone: after the radio sends emergency alarm, the background tone will be sent automatically in the way of emergency call.

◆ Alarm Type

None: no alarm feature (default).

Siren Only: after the radio enters the alarm state, the siren can only sound locally and the control center will not receive any alarm signals.

Conventional: after the radio enters alarm state, there will be light and sound alert and it can also receive response from other members.

Secret: after the radio enters alarm state, there will be no light or sound alert, and it cannot receive response

from other members.

Secret with Voice: after the radio enters alarm state, there will be no light or sound alert but it can receive response from other members.

Note:

Emergency Alarm: the radio transmits non-speech signal to trigger the alarm sent from other radios.

Emergency Call: it is a call mode which is faster in occupying channel than common calls, which ensures smooth call in emergency.

7.7 Enabling Color Code on Digital Mode

Only when both the color code and ID matches, the speaker can be turned on to receive.

Range: 0~15 (16 groups of color codes)

7.8 Technical Parameters

Frequency Range: 400MHz to 480MHz;

RF Output Power: High Power: 4W. Low Power: 1W;

Modulation Type:

Analog Voice: FM, Digital Data: 4FSK;

Channel Separation: Analog Voice: 12.5kHz; Digital Data: 12.5kHz;

8 Trouble shooting

No.	Problem	Cause and Solution
1	Failed to power on	A. The battery is used up –charge the battery or change to a new battery; B. Volume switch is faulty – repair at the specified service station;
2	Small voice during call	A. speaks too far from the microphone – the ideal distance: 3-10cm; B. wrong volume setting – turn the volume knob clockwise to increase the volume;
3	Failed to transmit or receive	A. wrong channel parameters – reset the parameters and try again; B. the group identity for default contact is wrong – select a right group; C. Beyond the communication scope.